

Specifications (Wave Fluted Panel)

Chroma Fluted Panels are decorative elements that can be used for both commercial and residential interiors. Our products are also sustainable as wood fiber and resin can be recycled and reused.

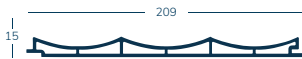

PROPERTIES



Product Features



Anti Mould
& Termites



Water
Resistant



Durable



Low
Maintenance



Easy
Installation



100%
Eco Friendly

Wave Fluted Panel

Curved columns can soften an interior space while also exhibiting exquisite taste.

Size: 209mm x 15mm
Length: 2800mm

Applications

Any kind of wall applications as decorative purposes for interior spaces.

Technical Specifications

Material: Wood powder, PVC, and other reinforcing additives
Fire rating: Available upon request
Formaldehyde: Formaldehyde free
Eco Certification: FSC 100%

Installation

Installation - Full Wall

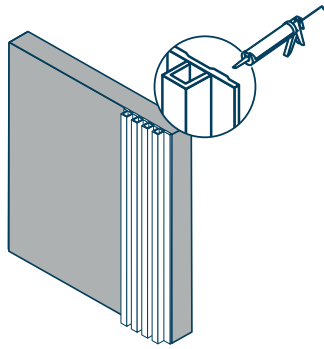

1. Install the first panel and use construction glue to fix in place.

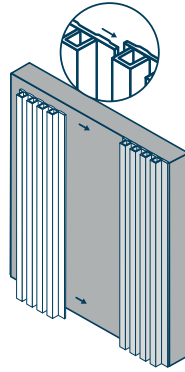

2. Install the second wall panel by placing the long connecting flap over the shorter flap.

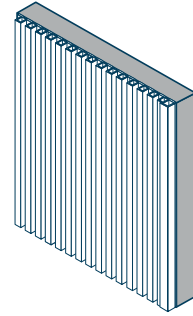

3. Install L capping.

Installation - Half Wall

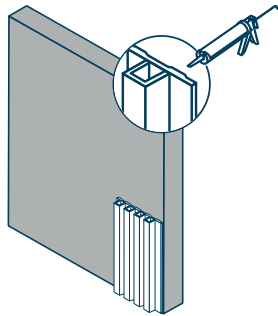

1. Install the first panel and use construction glue to fix in place.

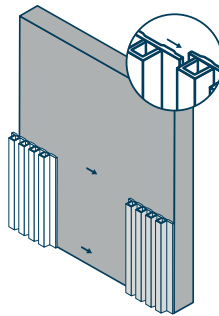

2. Install the second wall panel by placing the long connecting flap over the shorter flap.

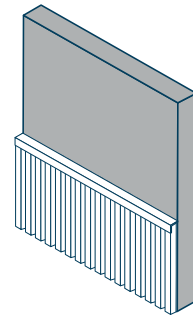

3. Install L capping.

Colour Chart

